

# DT9828

## Low-Cost, Isolated, Thermocouple Measurement Module

The DT9828 is an **8-channel, isolated thermocouple DAQ module** that features **superb accuracy** yet is **low-cost** and **easy-to-use**. The DT9828 supports a range of thermocouple types and includes QuickDAQ application software to get up and running quickly.

### Key Features:

- **8 differential** analog input channels for thermocouple or voltage measurements
- **Excellent accuracy** of 0.09°C and noise of 0.1°C for thermocouples
- **24-bit resolution**, sampling rates of up to 600Hz
- **±500V galvanic isolation** for all analog and digital I/O... noise-free data
- **Complete support** for B, E, J, K, N, R, S, and T thermocouple types
- **Input range** of ±156mV
- **QuickDAQ** application to acquire, analyze and display temperature data
- **Compatible** with LabVIEW and MATLAB
- **USB bus-powered** for portability

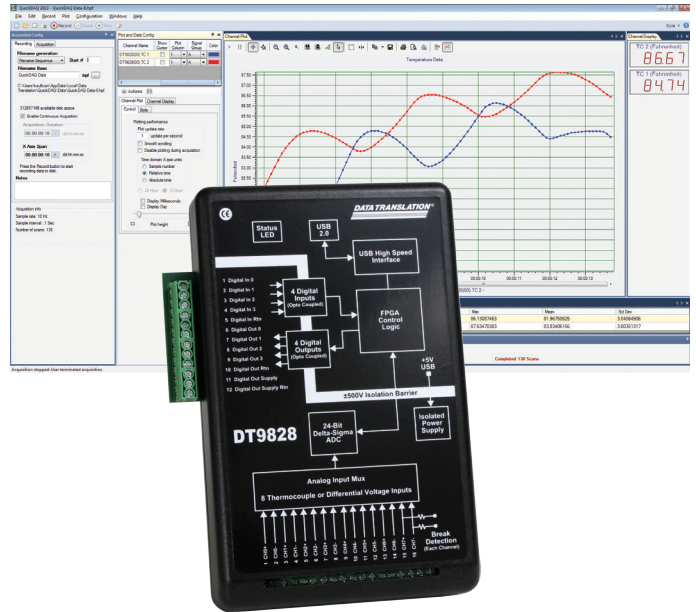

Figure 1: The low-cost DT9828 thermocouple measurement module, combined with the included QuickDAQ ready-to-measure application software, is a powerful temperature data logger. Accuracy to 0.09°C, low noise, and sampling to 600Hz allow high quality measurement far beyond other products.

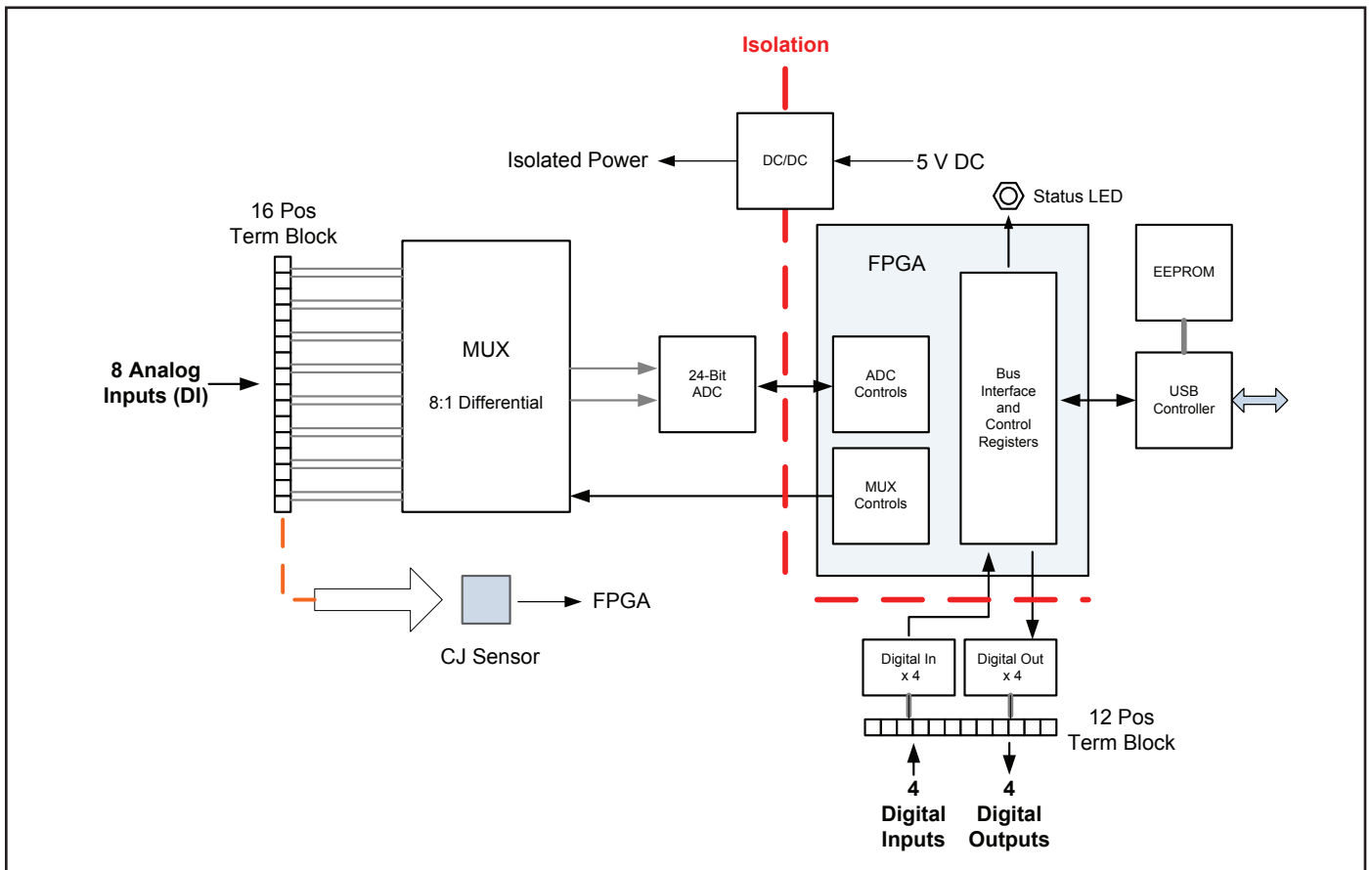

Figure 2: DT9828 block diagram.

## System Temperature Error

Table 1 lists the typical accuracy errors and Table 2 lists the maximum accuracy errors of the DT9828 for each thermocouple type at several thermocouple measurement values.

The values in Table 1 are the typical errors expected when the module is operating at 23° C ±5° C ambient.

**Table 1: Typical Thermocouple Measurement Accuracy of the DT9828 at 23° C ±5° C**

Thermocouple Temp.	Thermocouple Type <sup>1</sup>							
	J	K	T	E	S	R	B	N
-100° C	±0.06° C	±0.08° C	±0.08° C	±0.05° C	—	—	—	±0.13° C
0° C	±0.05° C	±0.08° C	±0.1° C	±0.06° C	±0.58° C	±0.6° C	—	±0.13° C
100° C	±0.1° C	±0.1° C	±0.09° C	±0.08° C	±0.43° C	±0.42° C	—	±0.12° C
300° C	±0.13° C	±0.18° C	±0.14° C	±0.12° C	±0.38° C	±0.36° C	±0.99° C	±0.16° C
500° C	±0.19° C	±0.2° C	—	±0.17° C	±0.4° C	±0.37° C	±0.65° C	±0.2° C
700° C	±0.24° C	±0.24° C	—	±0.23° C	±0.43° C	±0.4° C	±0.52° C	±0.25° C
900° C	±0.25° C	±0.34° C	—	±0.29° C	±0.46° C	±0.42° C	±0.47° C	±0.3° C
1100° C	±0.33° C	±0.38° C	—	—	±0.48° C	±0.44° C	±0.45° C	±0.36° C
1400° C	—	—	—	—	±0.54° C	±0.5° C	±0.46° C	—

The values in Table 2 are the maximum errors expected when operating the module over the full specified temperature range of 0° C to 50° C.

**Table 2: Typical Thermocouple Measurement Accuracy of the DT9828 at 0° C to 50° C**

Thermocouple Temp.	Thermocouple Type <sup>1</sup>							
	J	K	T	E	S	R	B	N
-100° C	±0.19° C	±0.23° C	±0.24° C	±0.16° C	—	—	—	±0.34° C
0° C	±0.19° C	±0.24° C	±0.26° C	±0.19° C	±1.34° C	±1.39° C	—	±0.33° C
100° C	±0.26° C	±0.27° C	±0.26° C	±0.23° C	±1.0° C	±0.99° C	—	±0.33° C
300° C	±0.34° C	±0.41° C	±0.34° C	±0.3° C	±0.89° C	±0.85° C	±2.28° C	±0.39° C
500° C	±0.45° C	±0.48° C	—	±0.4° C	±0.92° C	±0.86° C	±1.48° C	±0.47° C
700° C	±0.53° C	±0.57° C	—	±0.52° C	±0.98° C	±0.91° C	±1.19° C	±0.57° C
900° C	±0.6° C	±0.74° C	—	±0.64° C	±1.03° C	±0.95° C	±1.08° C	±0.67° C
1100° C	±0.75° C	±0.86° C	—	—	±1.08° C	±0.99° C	±1.03° C	±0.8° C
1400° C	—	—	—	—	±1.21° C	±1.11° C	±1.04° C	—

<sup>1</sup> Conditions for accuracy measurements:

- Module has been calibrated and warmed up for 10 minutes.
- Module is calibrated at 23° C.
- CJC offset is nulled using CJC calibration process.
- The module is operated in a stable environment within the specified limits.
- Inclusive of CJC error and input offset, gain, linearity, and long-term stability errors.
- Exclusive of thermocouple errors.
- Exclusive of noise.
- Specifications are valid for 1 year from calibration.

QuickDAQ quickly and easily performs sophisticated measurements in 8 simple steps.

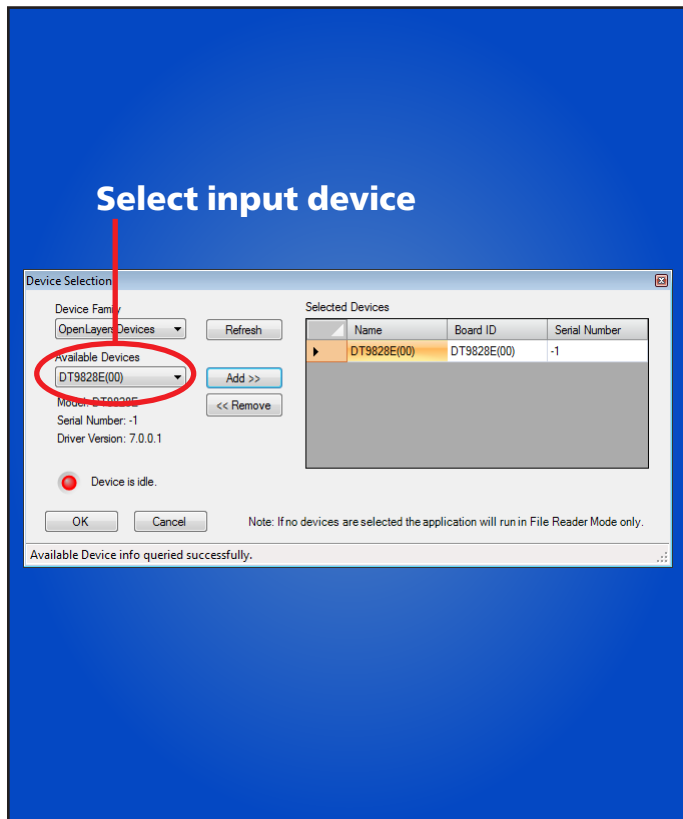

STEP 1: Select Input Device (DT9828),

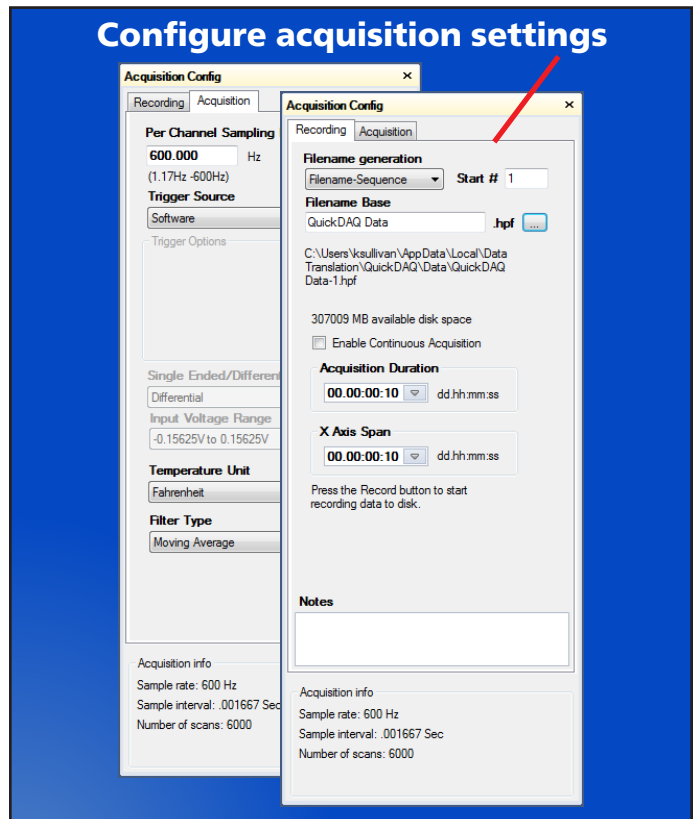

STEP 2: Use the Recording and Acquisition tabs to configure the acquisition settings, including the acquisition duration, sampling frequency, and trigger to use.

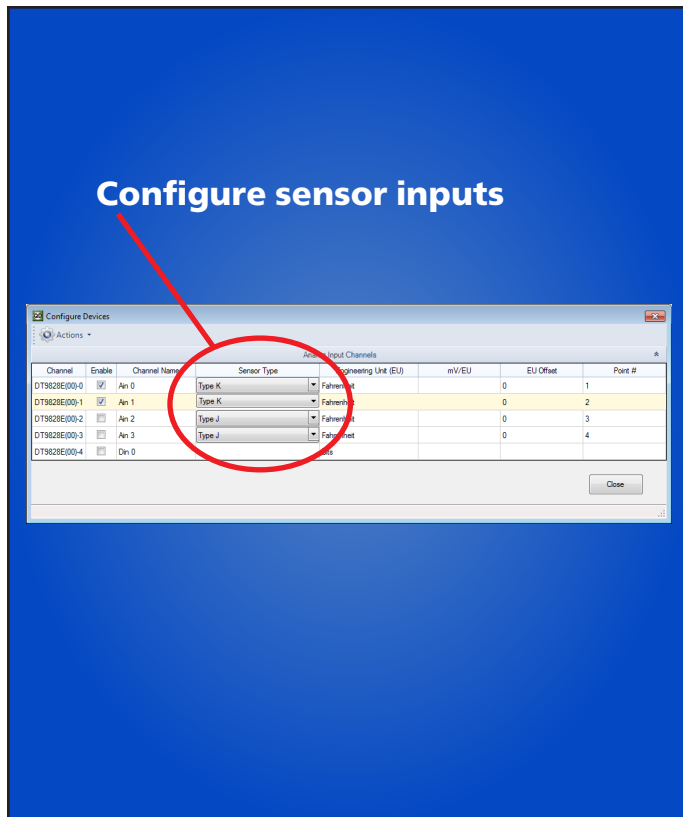

STEP 3: Configure settings for channels in the analog input data stream, including the channel name, sensor type, engineering units, and scaling factors.

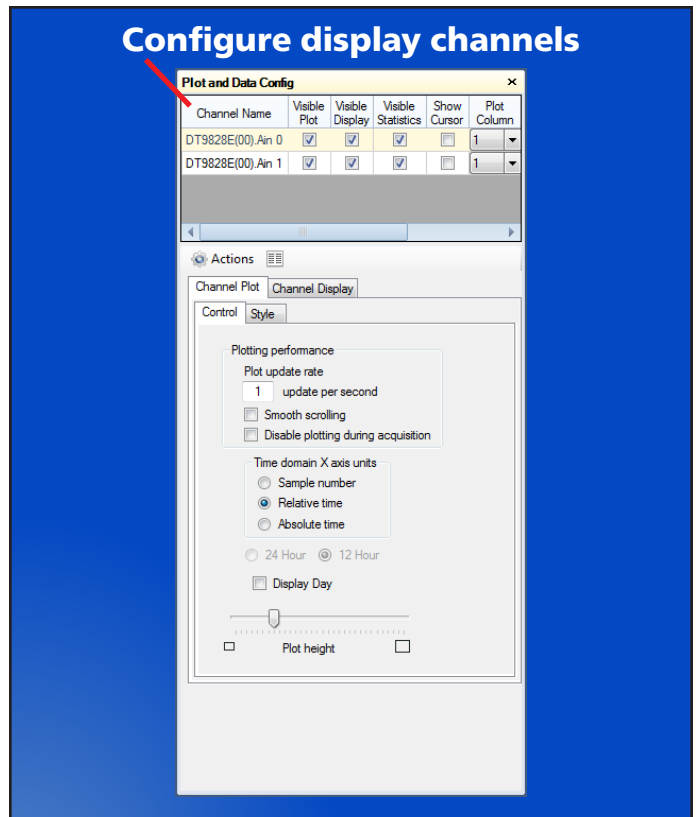

STEP 4: Use the Plot and Data Config window to select the channels to display and to configure the appearance of the display.

## Record data

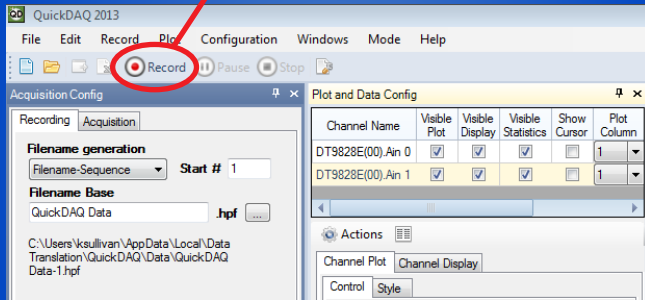

**STEP 5:** Press the Record button to start the acquisition of continuous, gap-free data.

## Analyze



**STEP 6:** Use the Channel Plot, Channel Display, and Statistics windows to view and analyze the acquired data.

## View data in Excel

Channel Name	X Axis Units	Y Axis Units	Time	Real	Real
DT9828E(00).Ain 0	Sec	Deg F	0.00E+00	85.19741783	84.65908432
DT9828E(00).Ain 1	Sec	Deg F	3.87E-08	85.19591751	84.65701752
	Real	Real	7.73E-08	85.19106293	84.65029526
			1.16E-07	85.18811722	84.64207611
			1.55E-07	85.17943459	84.6391304
			1.93E-07	85.17731628	84.63179016
			2.32E-07	85.16780624	84.62605324
			2.71E-07	85.16331215	84.62496834
			3.09E-07	85.15633583	84.62372894
			3.48E-07	85.1540081	84.62238312
			3.87E-07	85.1518383	84.61886749
			4.25E-07	85.1517868	84.61493988
			4.64E-07	85.15163231	84.61054535
			5.03E-07	85.14915009	84.60827255
			5.41E-07	85.14791069	84.60088081
			5.80E-07	85.1497715	84.59431648

**STEP 7:** Click the Open Current Data in Excel button to analyze the data in Excel.

## Export data

**STEP 8:** Specify how to save the data. Supported file formats include tab-delimited text (.TXT) and comma-delimited text (.CSV).

## QuickDAQ

QuickDAQ allows you to acquire and display from all Data Translation USB and Ethernet data acquisition devices that support analog input streaming. Combine QuickDAQ with Data Translation hardware to acquire data, record data to disk, display the results in both a plot and digital display, and read a recorded data file. Be productive right out of the box with this powerful data logging software. Data can be exported to other applications like Microsoft Excel® and The Mathworks MATLAB® for more advanced analysis. Two additional options can be purchased to add FFT analysis capabilities to the base package.

### Key Features:

- **QuickDAQ Base Package (Free)**
  - Ready-to-measure application software
  - Configure, acquire, log, display, and analyze your data
  - Customize many aspects of the acquisition, display, and recording functions to suit your needs
- **FFT Analysis Option (License Required)**
  - Includes all the features of the QuickDAQ Base Package
  - Perform single-channel FFT operations including:
    - ◆ Auto Spectrum
    - ◆ Spectrum
    - ◆ Power Spectral Density
  - Configure and view dynamic performance statistics
  - Supports Hanning, Hamming, Bartlett, Blackman, Blackman Harris, and Flat Top response windows
- **Advanced FFT Analysis Option (License Required)**
  - Includes all the features of the QuickDAQ Base Package and FFT Analysis Package
  - Perform 2-channel FFT operations including:
    - ◆ FRF
    - ◆ Cross-Spectrum
    - ◆ Cross Power Spectral Density
    - ◆ Coherence
    - ◆ Coherent Output Power
  - Supports real, imaginary, and Nyquist display functions
  - Additional FFT analysis functions supported: Exponential, Force, Cosiner Taper
  - Save data to .uff file format

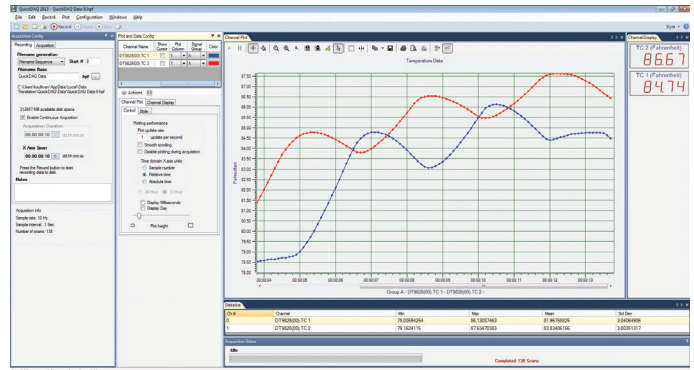

**Figure 3: QuickDAQ ships free-of-charge and allows you to get up and running quickly.**

## Other Software Options

There are many software choices available for application development, from ready-to-measure applications to programming environments.

The following software is available for use with the DT9828 module and is provided on the Data Acquisition Omni CD:

- **DT9828 Device Driver** –The device driver allows you to use a DT9828 module with any of the supported software packages or utilities.
- **DT9828 Calibration Utility** – This utility allows you to calibrate features of a DT9828 module.
- **Quick DataAcq** application – The Quick DataAcq application provides a quick way to get up and running. Using this application, verify key features of the module, display data on the screen, and save data to disk.
- **DT-Open Layers® for .NET Class Library** – Use this class library if you want to use Visual C#® or Visual Basic® for .NET to develop application software using Visual Studio® 2003-2012; the class library complies with the DT-Open Layers standard.
- **DataAcq SDK** – Use the Data Acq SDK to use Visual Studio 6.0 and Microsoft® C or C++ to develop application software using Windows® XP/Vista/7/8; the DataAcq SDK complies with the DT-Open Layers standard.
- **DAQ Adaptor for MATLAB** – Data Translation’s DAQ Adaptor provides an interface between the MATLAB® Data Acquisition (DAQ) toolbox from The MathWorks™ and Data Translation’s DT-Open Layers architecture.
- **LV-Link** – Data Translation’s LV-Link is a library of VIs that enable LabVIEW™ programmers to access the data acquisition features of DT-Open Layers compliant USB and PCI devices.

## Specifications

### Basic Module Specifications

Feature	Specifications
Number of analog input channels	8 Differential (0 to 7), Isolated
Number of digital input lines	4 Isolated, TTL, 12 V and 24 V digital inputs
Number of digital output lines	4 Isolated, open-collector digital outputs
Input functions	Thermocouples or voltage inputs
A/D converter type	High stability 24-bit Delta-Sigma with 8 channel multiplexor
Data coding Analog input: Digital I/O:	32-Bit floating point Binary

### Thermocouple Specifications

Feature	Specifications
Number of thermocouple channels	Up to 8 thermocouples
Thermocouple types (software-selectable)	J, K, T, B, E, N, R, S
A/D converter resolution	24 bits
Full-scale input range	±156.25 mV
Aggregate sample rate (throughput)	600 Samples/s maximum
Sampling mode	Multiplexed to Delta-Sigma A/D
Accuracy (for Type K thermocouples)	0.09° C typical; thermocouple at 25° C
Noise (for Type K thermocouples)	0.1° C peak to peak, typical, with moving average filter
DC differential input impedance	10 MΩ
Open thermocouple detect current	250 nA
Input common mode voltage	±500 V maximum
Differential input voltage	±10 V maximum (protection)
Common mode rejection @ 50 Hz and 60 Hz	120 dB
Warm-up time	10 minutes

### Input Voltage Noise and CJC Sensor Noise for the DT9828

Throughput (Samples/s)	Input Voltage Noise (µV pk-pk)		CJC Noise (Degrees C pk-pk)	
	Moving Average Filter	No Filter	Moving Average Filter	No Filter
600	3.0	12.0	0.01	0.025
100	1.5	4.0	0.01	0.025
60	1.0	3.0	0.01	0.025
10	0.5	1.0	0.01	0.025



## Voltage Measurement Specifications

Feature	Specifications <sup>1</sup>
Number of voltage channels	Up to 8 differential voltage inputs
A/D converter resolution	24-bits
Full-scale input range	±156.25 mV
Aggregate sample rate	600 Samples/s maximum
Sampling mode	Multiplexed
DC differential input impedance	10 MΩ
Input bias current	250 nA
Input common mode voltage	±500 V maximum
Differential input voltage	±10 V maximum (protection)
Common mode rejection @ 50 Hz and 60 Hz	120 dB
Noise	3 μV pk-pk at maximum throughput
Input signal bandwidth, -3 dB	5 Hz
Offset error <sup>2</sup>	±20 μV
Gain error	±0.03% of reading
Linearity error	±2 μV maximum
Offset error tempco	±20 nV/°C
Gain error tempco	±0.0015% of reading/°C

<sup>1</sup> Conditions for specification:  
 Module is calibrated at 23° C.  
 Values are typical for the module operated at 23° C ±5° C environment.  
 Valid for 1 year from calibration

<sup>2</sup> Voltage source impedance ≤ 50 ohms.

## Digital I/O Specifications

Feature	Specifications
Number of digital I/O lines	8 (4 in, 4 out)
Number of ports	2 (4 bits each)
Digital Inputs Input characteristics: Input type: Input high voltage: Input low voltage: Input voltage limits:	Level-sensitive LVC (low voltage) logic 2.0 V minimum 0.8 V maximum -5 V to +12 V
Digital Outputs Output characteristics: High output: Low output:	LVC (low voltage) logic 2.4 V minimum, 4.5 mA sourcing 0.6 V maximum, 10 mA sinking
Interrupt on change	No
Inputs clocked with sample clock	Yes
Software I/O selectable	No

## Isolation and Protection Specifications

Feature	Specifications
ESD protection per standard EN6100-4-2:2009 Arc: Contact:	8 kV 4 kV
Isolation voltage from analog input and digital I/O to the host computer	±500 V operational

## Power, Physical, and Environmental Specifications

Feature	Specifications
Power	+5 V $\pm$ 5% from USB host; 200 mA maximum
Physical Dimensions	Height: 1.472 inches (37.39 mm) Width: 4.175 inches (106.05 mm) Length: 6.030 inches (153.16 mm)
Weight	6.85 oz (197 g)
Environmental Operating temperature range: Storage temperature range: Relative humidity:	0° C to 55° C -25° C to 85° C To 95%, noncondensing

## Terminal Block Specifications

Feature	Specifications
Analog Input Screw Terminal Block (TB1)	16-Position Header: Phoenix Contact 3.5 mm, 1984756
Digital I/O Screw Terminal Block (TB2)	12-Position Header: Phoenix Contact 3.5 mm vertical, 1984714

## Cross-Series Compatibility

Virtually all Data Translation data acquisition modules are compatible with the DT-Open Layers® software standard. This means any application developed with one of Data Translation's software products can easily be upgraded to a new Data Translation module with little to no reprogramming needed.

## Ordering Summary

### HARDWARE:

- DT9828

### FREE SOFTWARE

- QuickDAQ
- DAQ Adaptor for MATLAB – Access the analysis and visualization tools of MATLAB®.
- LV-Link – Access the power of Data Translation boards through LabVIEW™.

### OPTIONAL SOFTWARE

- QuickDAQ FFT Analysis Option (License Required)
- QuickDAQ Advanced FFT Analysis Option (License Required)